

SECTION B-B

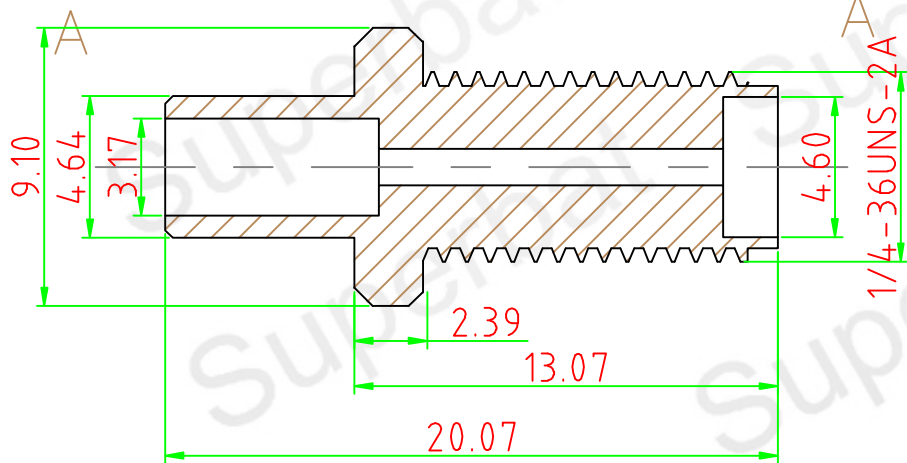

SECTION A-A

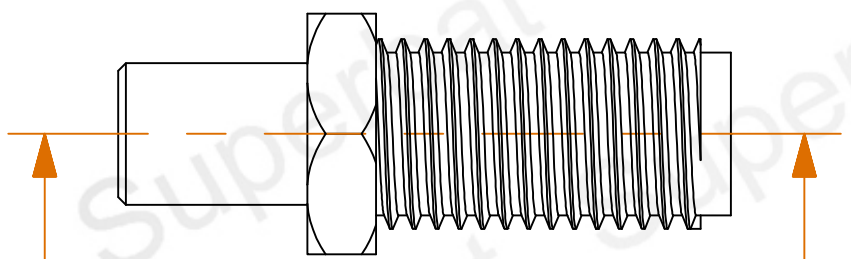
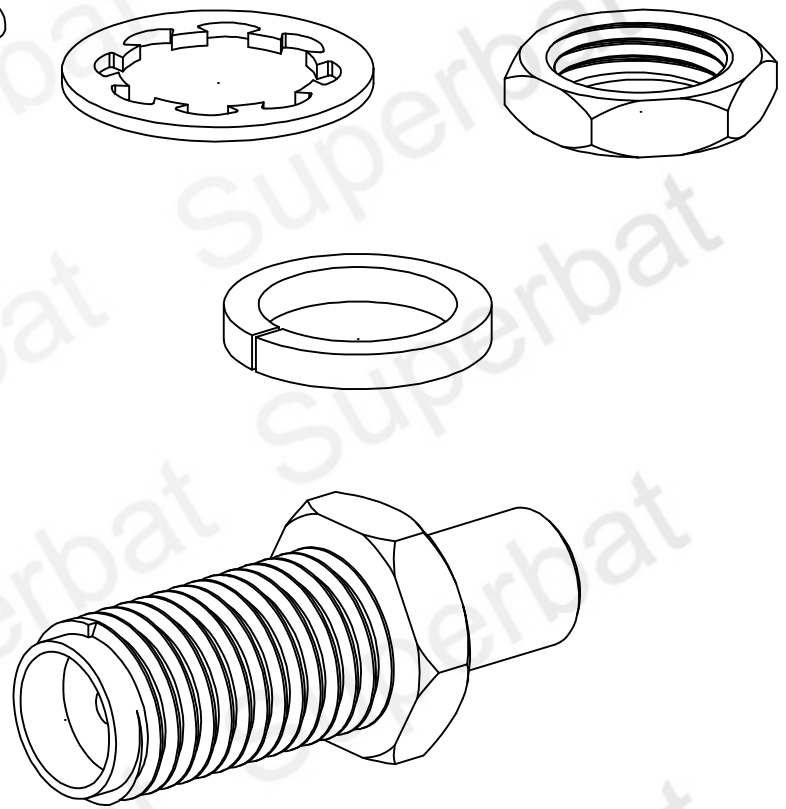

Draw up	Verify	Scale 1:1	Filename	Date 2012/03/04	Unit:MM
Email:Paypal@rfsupplier.com			S01-BHL19-11BS00		
Company Website: www.rfsupplier.com		TEL 8613923809471	Drawing	Qinxianfeng	
 Shenzhen Superbat Electronics Co.,Ltd			A module cable	Page1	Open up 1/1